

Central Article Code: D04068C01-A
 Local Code: EG1203

Created: 16/10/2012
 Modified: 20/12/2018

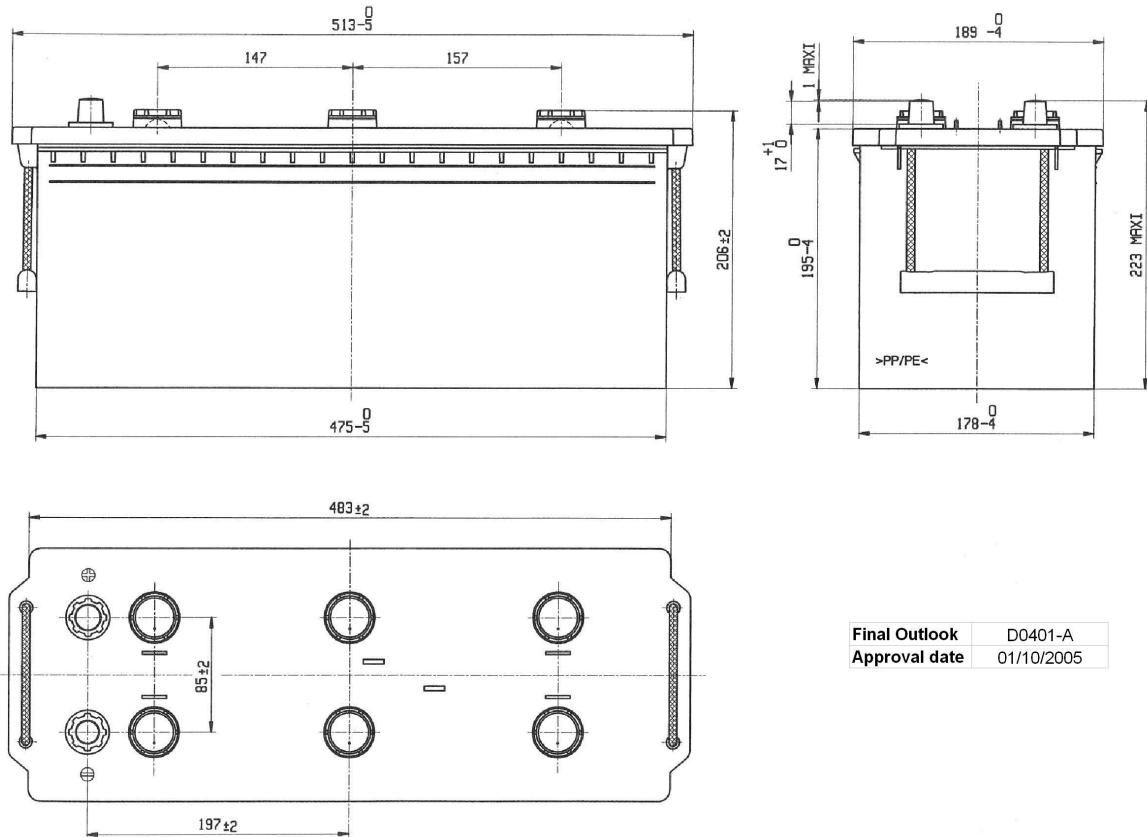

Final Outlook	D0401-A
Approval date	01/10/2005

PERFORMANCES

Voltage (V):	12 V	
C20 (Ah):	120.0	20 h
Cranking (A):	680	EN
Charge:	WET	
Technology:	Vented/Flooded	
Grid:	Ca/Ca	

STD. DIMENSIONS

Length (mm ± 2):	513
Width (mm ± 2):	189
Height (mm ± 2):	223
Total Weight (kg ± 5%):	32.50

All figures show nominal values. Tolerances are according to EN50342 and applicable European Regulations.

CONTAINER

Type:	D04	BLACK
Hold Down:	B0	
H.D. Adapter:	No	

COVER

Type:	Flat/Screw	BLACK
Polarity:	ETN 3	
Terminals:	EN taper post	
Terminal Adapter:	No	
SOCI:	No	
Ventilation:	Independent	
Filter:	No	
Lateral Plug:	No	

PLUGS

Type:	6 x M27	BLACK
-------	---------	-------

HANDLES

Type:	2 x Rope (Rigid holde	BLACK
-------	-----------------------	-------

OTHERS

Degassing Tube:	No
-----------------	----