

Central Article Code: C35012L03-A
 Local Code: ELTZ5S

Created: 29/09/2016
 Modified: 13/12/2016

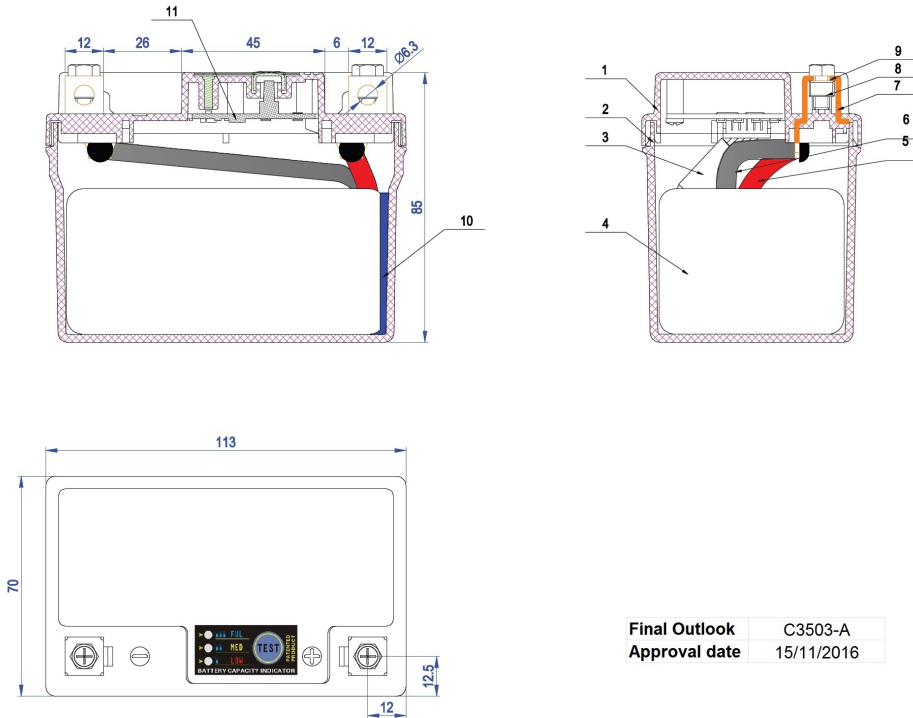

Final Outlook	C3503-A
Approval date	15/11/2016

PERFORMANCES		CONTAINER	
Voltage (V):	12 V	Type:	C35 BLACK
C20 (Ah):	2.0 10 h	Hold Down:	B0
Cranking (A):	120 25° test	H.D. Adapter:	No
Charge:	CHARGED	COVER	
Technology:	Li-ion	Type:	Motorbike (centr ORANGE (Li-ion MC))
Grid:	LiFePO4	Polarity:	ETN 0
		Terminals:	M12
		Terminal Adapter:	No
		SOCI:	Digital SOCI
		Ventilation:	Central
		Filter:	No
		Lateral Plug:	No
STD. DIMENSIONS		PLUGS	
Length (mm ± 2):	115	Type:	1 x Not define NOT SIGNIFICANT
Width (mm ± 2):	70	HANDLES	
Height (mm ± 2):	85	Type:	None
Total Weight (kg ± 5%):	0.50	OTHERS	
		Degassing Tube:	No

All figures show nominal values. Tolerances are according to EN50342 and applicable European Regulations.